

Lighting for Explosive Environments - The 380 Portable Light Cart is manufactured in accordance with applicable NFPA standards. For use in hazardous environments and laboratory applications. Portable lighting solutions for hazardous atmospheres. Light can be directed where you need it most. Fixture(s) sold separately. LDPI recommends consulting local authorities for approval of your application prior to purchase.

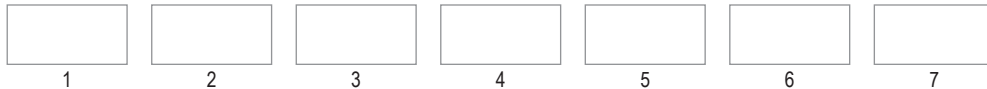
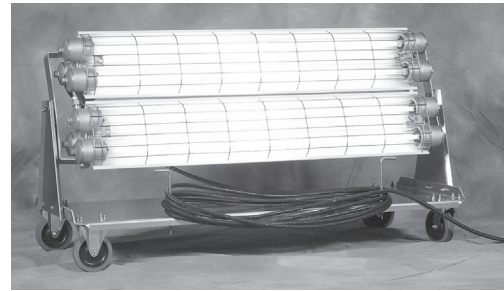

1 CART	2 SERIES	3 LAMP TYPE	4 LAMP QUANTITY	5 LENGTH
4372-2: 2 Lamp Cart 4372-3: 3 Lamp Cart 4372-4: 4 Lamp Cart	380	T5**: 28W T5HO*: 54W T8*: 32W T8HO***: 44W	2: 2 Lamps 3: 3 Lamps*** 4: 4 Lamps	4: 4 Ft.
6 VOLTAGE	7 OPTIONS	Notes: All T5, T5HO, T8, and T8HO are universal voltage *5000K lamp standard for T5HO and T8 lamps **4100K lamp standard for T8HO and T5 lamps ***3 lamp fixtures not available in T5 or T8HO LDPI® recommends consulting local electrical authorities for approval of your application prior to purchase.		
UNV: Universal Voltage 120-277V, 50/60Hz	HB: 93% Reflective specular reflector insert			

FIXTURE LISTINGS

UL listed 844 U.S. and Canada for hazardous locations
 UL listed 1598 U.S. and Canada for wet locations
 UL listed 1598A U.S. and Canada for marine locations

OPTIONS

2 lamp model (P/N 4372-2)
 3 lamp model (P/N 4372-3)
 4 lamp model (P/N 4372-4)

FEATURES

For either 2, 3 or 4-lamp 4 foot fixture
 5" non-sparking casters (1 pair fixed, 1 pair swivel)
 360° non-continuous adjustable fixture rotation
 Lamps, polycarbonate shield and stainless steel guard: ALL INCLUDED

ELECTRICAL

Available in 28, 32, 34, 44, 54 and 60 watt with T5, T5HO, T8 and T8HO lamps
 Voltages: 120
 50 Ft. of S.O. electric cable suitable for rough duty use
 Explosion proof switch
 Explosion proof plug - 120 Volts (P/N 3825)

HOUSING

Frame constructed of corrosion resistant aluminum

REFLECTOR

One piece aluminum reflector

LENS

Clear tempered glass tubes, polycarbonate shield.

MOUNTING

Fixture mounted to 360° (non-continuous) adjustable rotating brackets

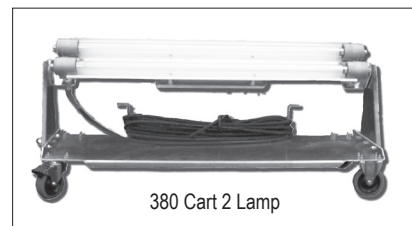

380 Cart 2 Lamp

CARTS

PORTABLE LIGHTING - EXPLOSION PROOF

Industrial • Task Lighting

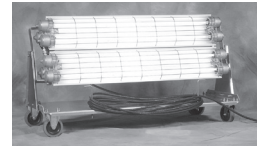

DIMENSIONS

2, 3 and 4 Lamp Cart

- A — 58"
- B — 24"
- C — 24 3/4"
- D — 27 5/8"
- E — 29 9/16"

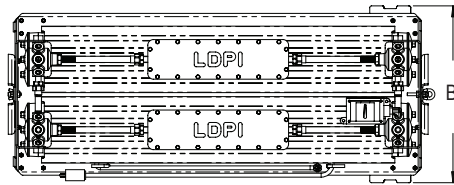
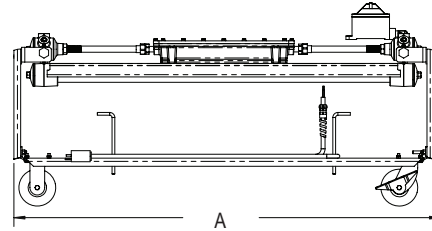
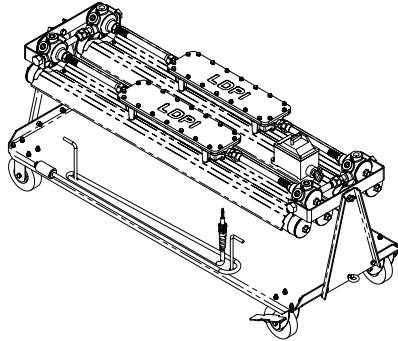

4 LAMP

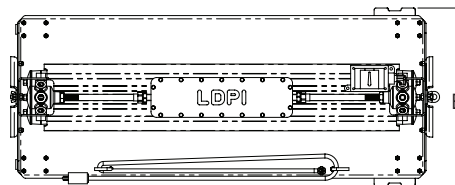

2 LAMP

